

—

□□□□□□□□□□□□□□

□

□□□□□□□□□□□□□□□□

□

□□□□□□□□□□

□

□□□□□□□□□□

□

□□□□□□□□□□□□

□

□□□□□□□□□□

目 录 Contents Page

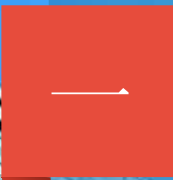
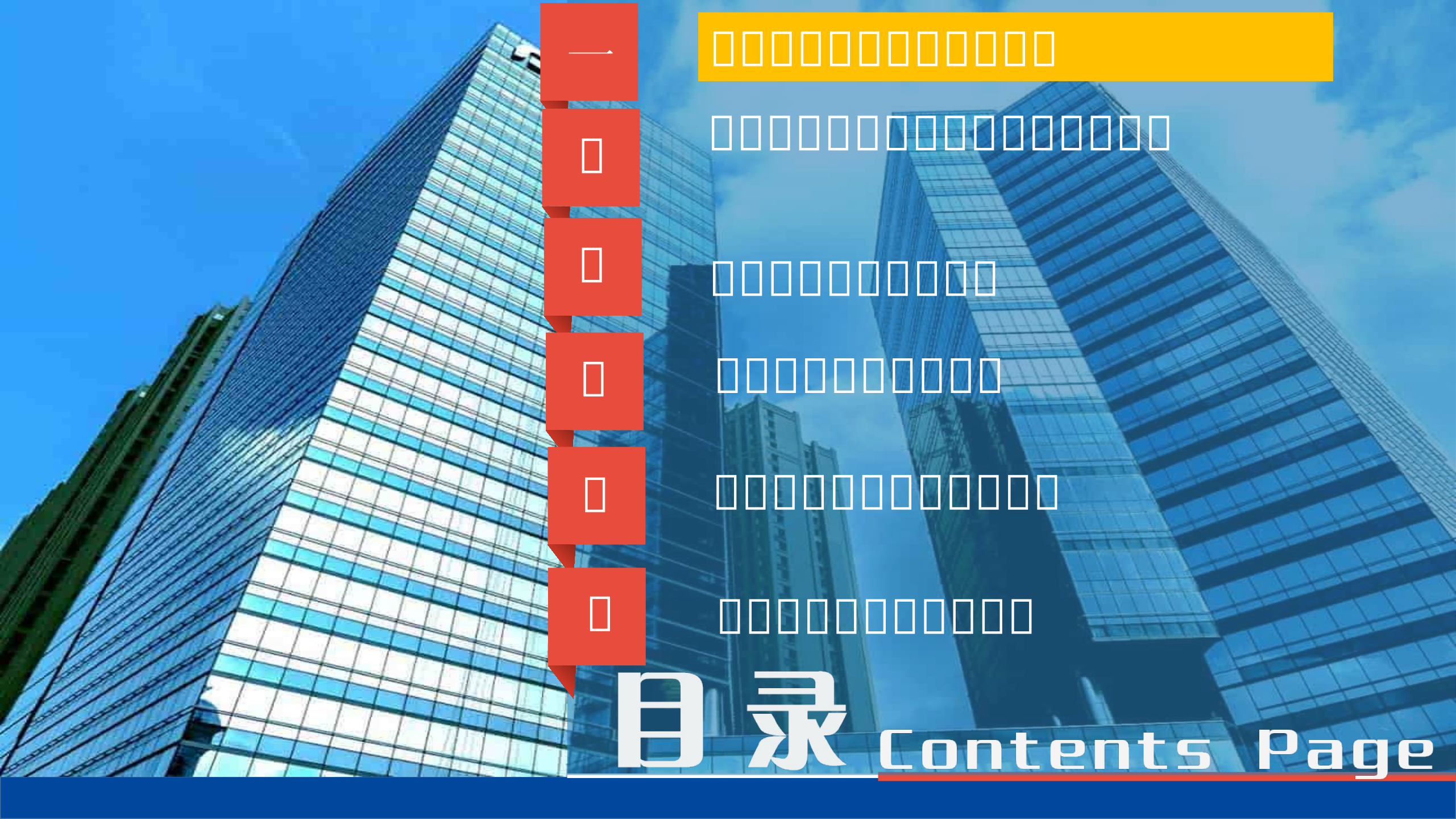

□□□□□□□□□□□□□□□□



□□□□□□□□□□□□□□□□



□□□□□□□□□□□□



□□□□□□□□□□□□



□□□□□□□□□□□□□□



□□□□□□□□□□□□

目录 Contents Page

□□□□□ ′ ′ °

1 “

2 ′ ′ □□□□□□□□

3 □□□□□□

□□□□□□□□



□□□□□□□□

□ □ □ □ □ □ □ □ □ □

1 □ □ □ □ □ □ □ □

2 □ □ □ □ □ □ □ □

3 □ □ □ □ □ □ □ □ □ □ □ □ □ □

4 □ □ □ □ □ □ □ □

5 □ □ □ □ □ □ □ □

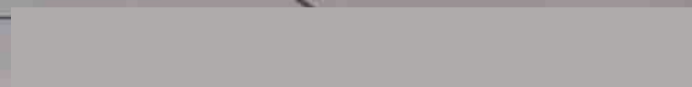
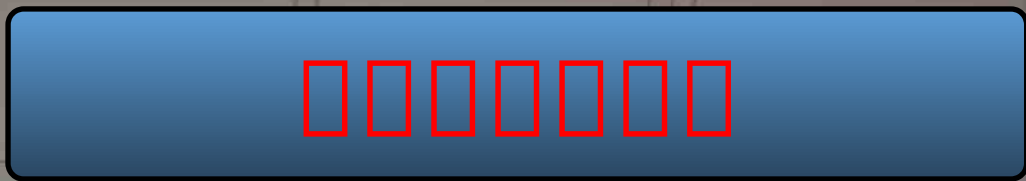

□□□□□□□□



□□□□□□□□

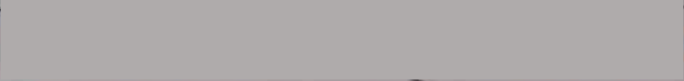

□ □ □ □ □ □ □ □ □



□ □ □ □ □ □ □ □ □ □

□□□□□□□□



□□□□□□



□□□□□

□□□□□□□□□□□□□□□□□□□□

□□□□□

① □□□□□□□□

② □□□□□□□□□□□□□□□□□□□□

□□□□□□□□□□□□□□□□□□□□

□□□□□

□□□□□□□□□□□□□□□□□□□□

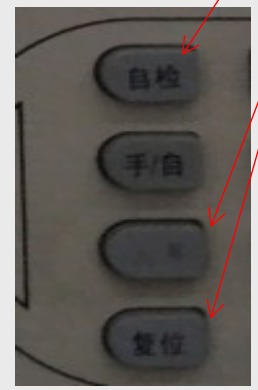

□ □ □ □ □ □ □ □ □ □ □ □ □ □ □ □



□ □ □ □ □ □ □ □ □ □ □ □ □ □

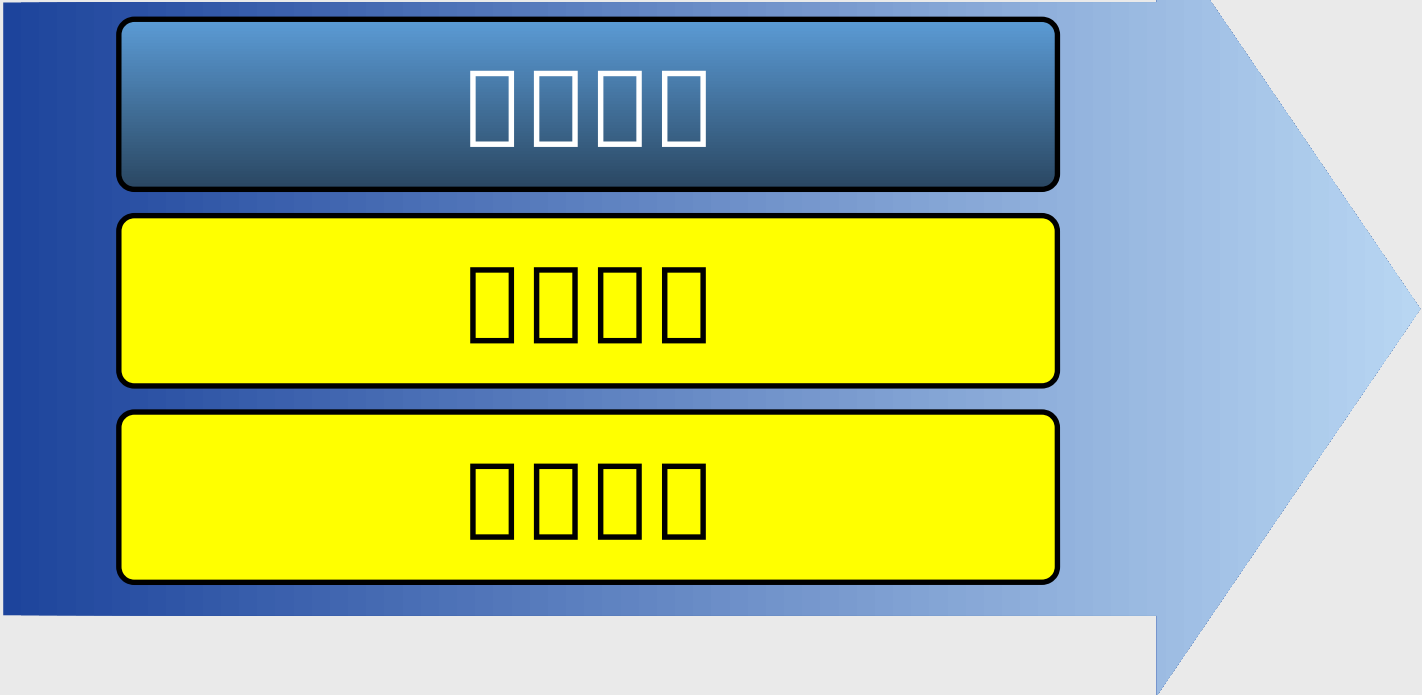

□ □ □ □ □



主电工作

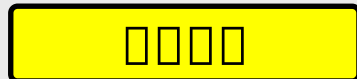

主电故障



- | | |
|---|---|
| <input type="radio"/> 主电工作
Power | <input type="radio"/> 备电工作
Battery |
| <input type="radio"/> 火警指示
Fire | <input type="radio"/> 反馈指示
Respond |
| <input type="radio"/> 启动指示
Startup | <input type="radio"/> 延时指示
Delay |
| <input type="radio"/> 气体喷洒
Gas Discharging | <input type="radio"/> 消音指示
Quiet |
| <input type="radio"/> 全局手动
Manual | <input type="radio"/> 全局自动
Auto |
| <input type="radio"/> 屏蔽指示
Shielding | <input type="radio"/> 输出禁止
No Outputting |
| <input type="radio"/> 系统故障
System Failure | <input type="radio"/> 公共故障
Common Failure |
| <input type="radio"/> 主电故障
Power Failure | <input type="radio"/> 备电故障
Battery Failure |
| <input type="radio"/> 通讯故障
Communication Failure | <input type="radio"/> 本机发送
Sending |
| <input type="radio"/> 监管报警
Supervisory Alarm | <input type="radio"/> 本机接收
Receiving |
| <input type="radio"/> 漏电报警
Leakage Alarm | <input type="radio"/> 漏电断电
Leakage Power-off |
| <input type="radio"/> 备用1
Spare 1 | <input type="radio"/> 备用2
Spare 2 |

备电工作



公共故障

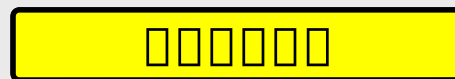

备电故障

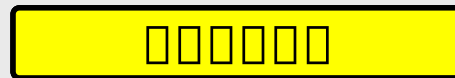



□□□□□□□□□□□□□□□□



□□□□□□□□□□

□□□□□□□□□□□□□□

□□□□□ 1. □□□□□□□

2. □□□□□□□□□□□□□□

3. °

□□□□□ 1. □□□□□□□ 2. ´

□ 3. °

□□□□□□□□□□□□□□

□□□□□ 1. □□□□□□□ 2. □□□□□□

□□□□□ 3. □

□□□□□ 1. □□□□□ 2. ´

3. °

□□□□□□□□□□



□□□□□□□□□□□□□□□□

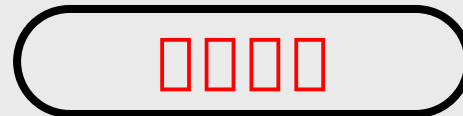
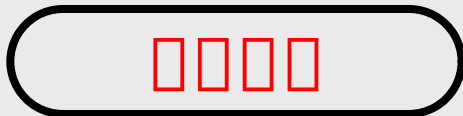
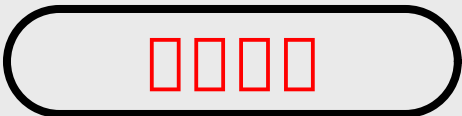
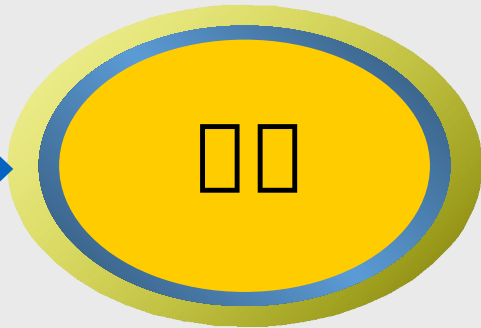
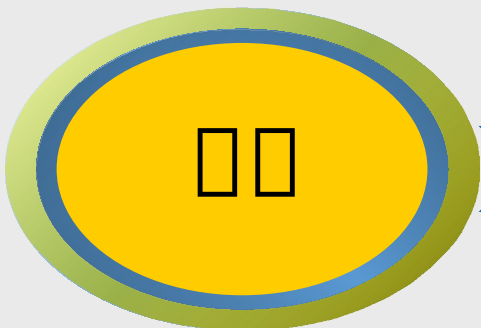
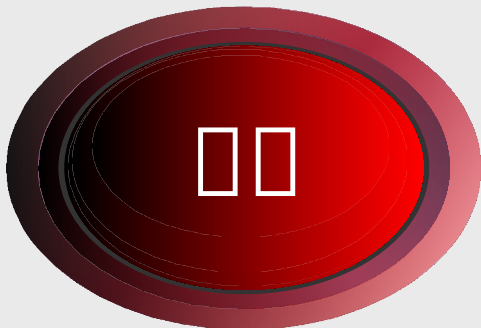

□ □ □ □ □ □ □ □ □ □ □ □

2 → □ □ □ □ □

□ □ □ □ □ □ □ □ □ □ □ □ □ □ □ □

□ □ □ □

□ □

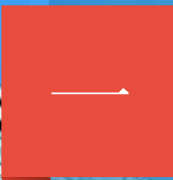
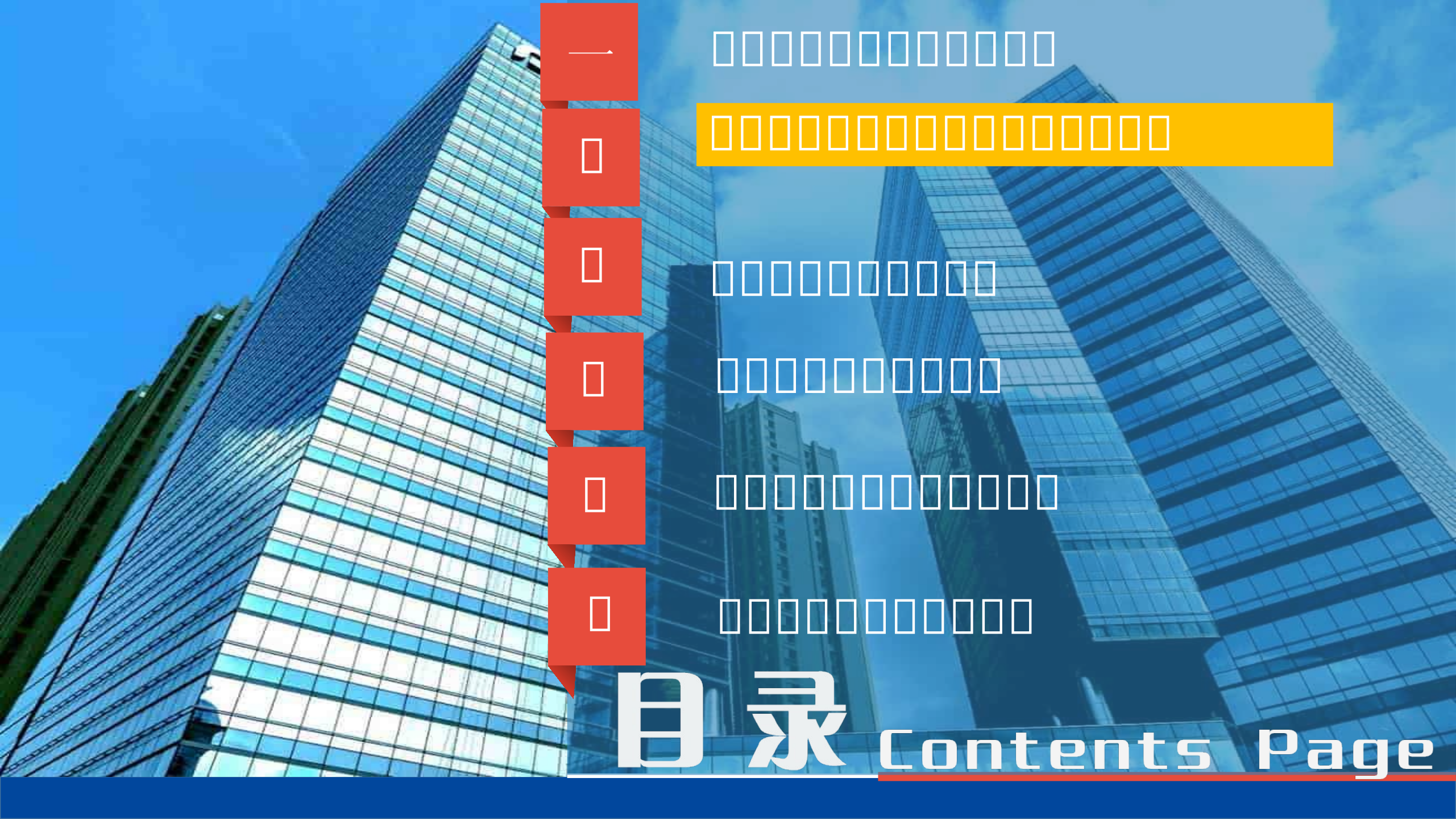

□□□□□□□□□□□□□□□□



□□□□□□□□□□□□□□□□□□□□



□□□□□□□□□□□□□□



□□□□□□□□□□□□□□



□□□□□□□□□□□□□□□□



□□□□□□□□□□□□□□

目录 Contents Page

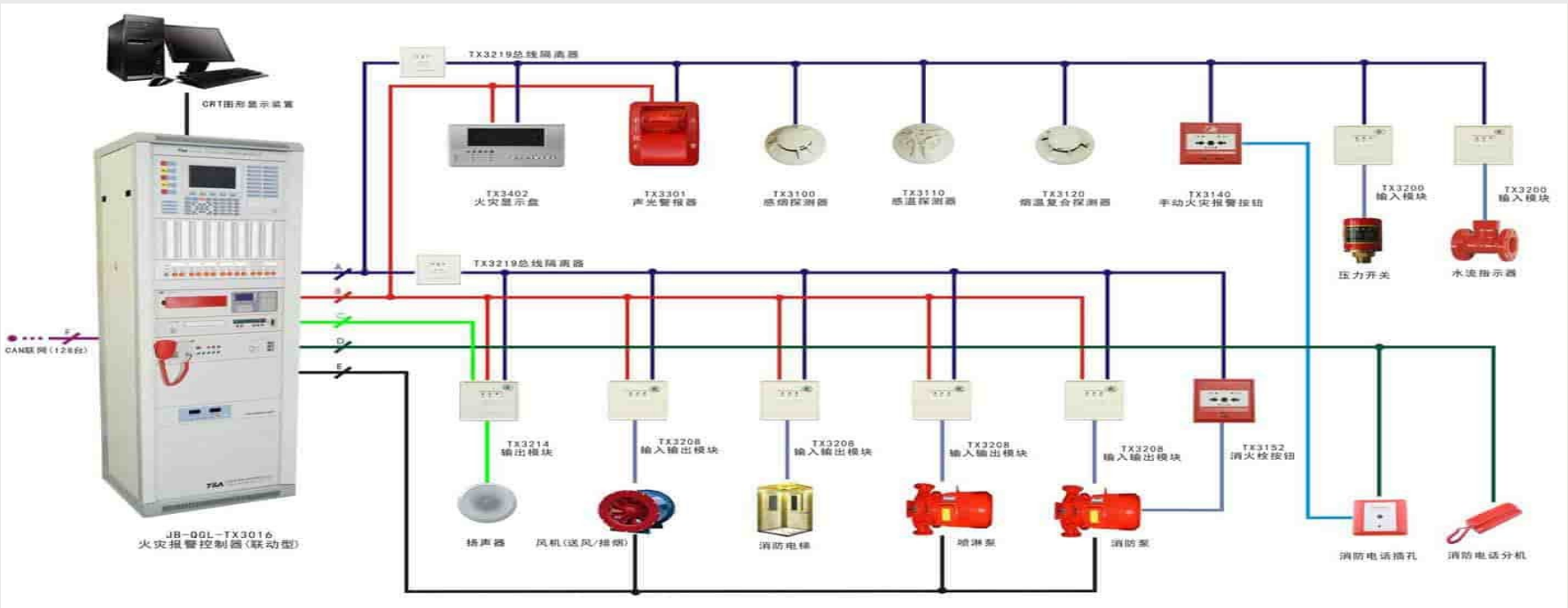
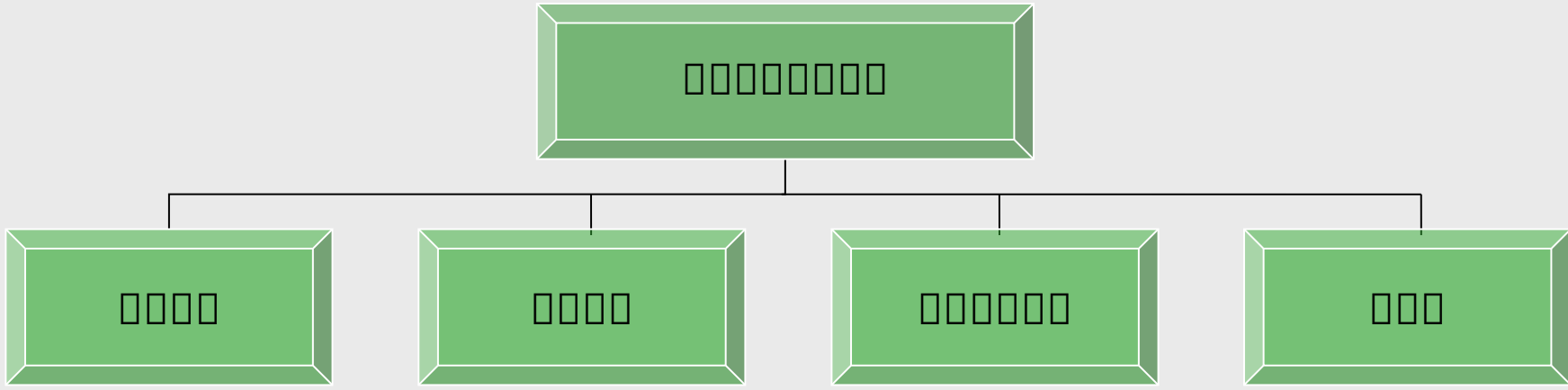

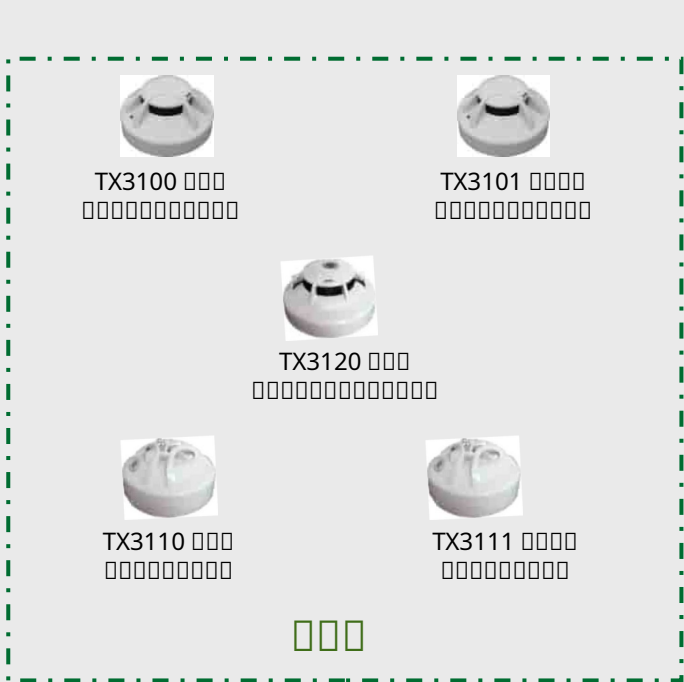





-

-

-

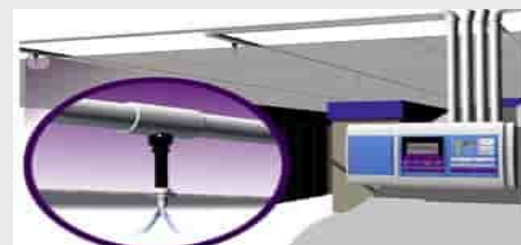
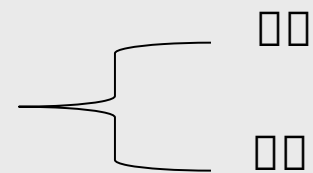
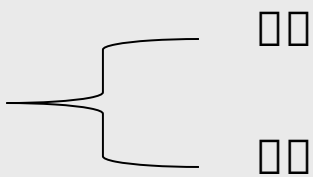
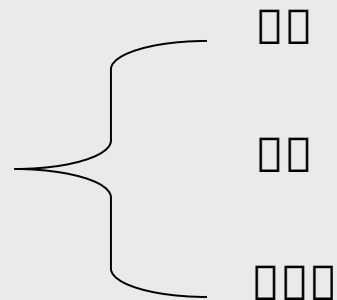

□ □ □ □

□ □ □ □ □ □ □ □ □ □

□ □ □ →

□ □ □ □ □ □ □ □

○







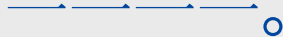

□ □ □ □ □

□ □ □ □ □ □ □ □

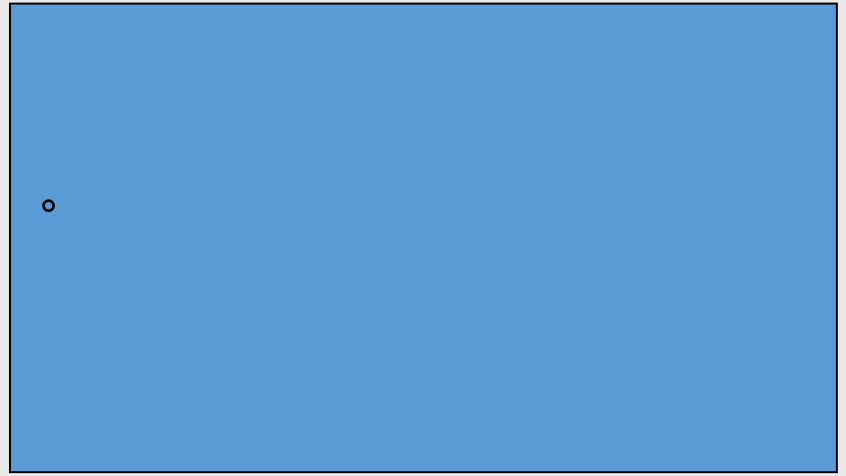

□ □ □ □

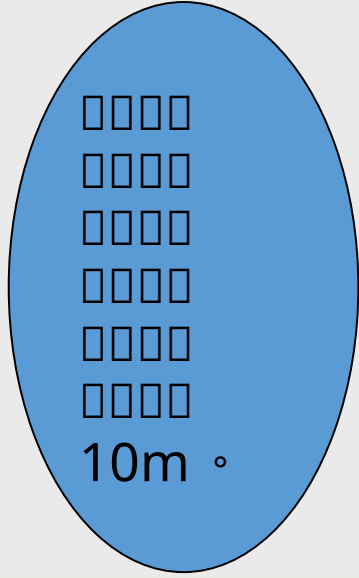
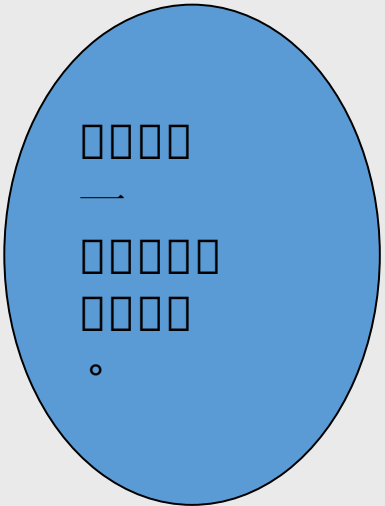

□□ :

• 1 ✓

• 2 ✓

10 □□□□□

○

○

□□□□□□ 0.5-1 ○

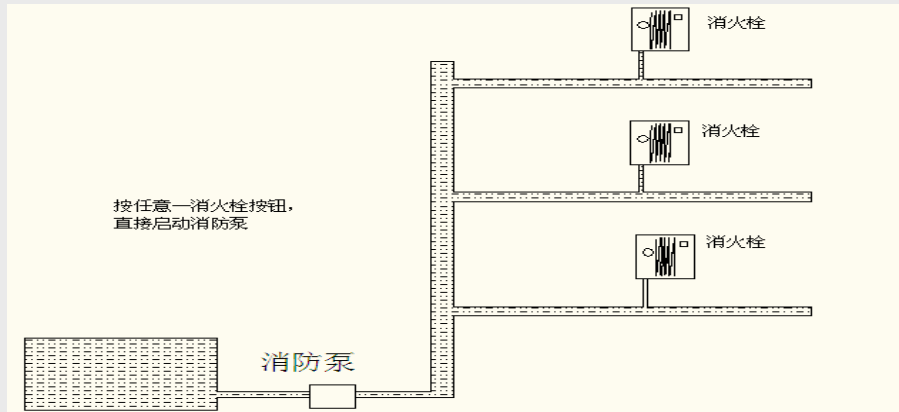

□ □ □ □ □ □ □ □ □ □ □ □

1 · 65 □

2 · 65 □ 100 □ □ □ □ □ □ □ □



□□□□□□□□□□



□□
□□
□□
□

□□
□□

□□
□□
□□

□□
□□
□□
□



□□
□□

□□
□□
□□
□



□□□□□□□□

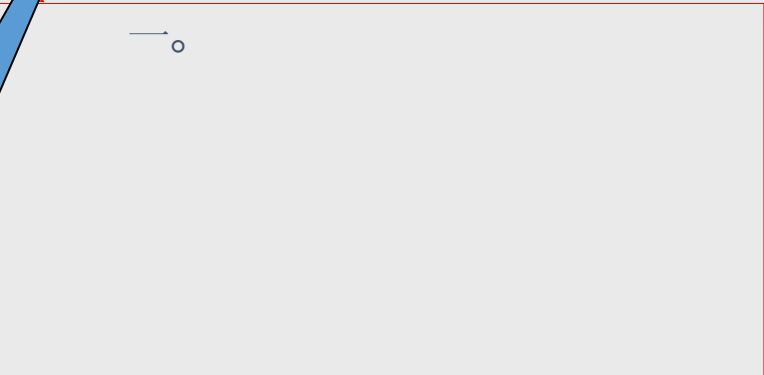

- □□□□□□□□ 160 / / / / /
- /
- —○—□—□ □ □
- □□

□□□□□□

—

1 ✓

2 □□□□□□ **ABC** □□ **BC** □□

3 □□□□□□□□□□□□□□□□

4 ✓✓ **IG541** □□



。 — BC 。 — ABC ☑

。 。

1kg ′ 2kg ′ 3kg ′ 4kg ′ 5kg ′ 6kg ′ 8kg ′ 9kg ′ 1

2kg □□□□□□□□□□□□□□□□

20kg ′ 50kg ′ 100kg ′ 125kg 。



□□□□□□□□

- — 1kg □□□□□□□□□□ 0.5m³ ◦ ◦ ◦ ◦ ◦ ◦ ◦
- 2kg ◦ 3kg ◦ 5kg ◦ 7kg □□□□□□□□□□□□□□□□ 10kg ◦ 20kg ◦ 30kg ◦ 50kg ◦



□□□□□□□□□□

□□□□□□□□□□

1、5 □□□□□□□□□□

2、

□□□□□□□□□□

1、10 □□□□□□□□□□

2、

—

3、

4、°



□□□□□□□□□□



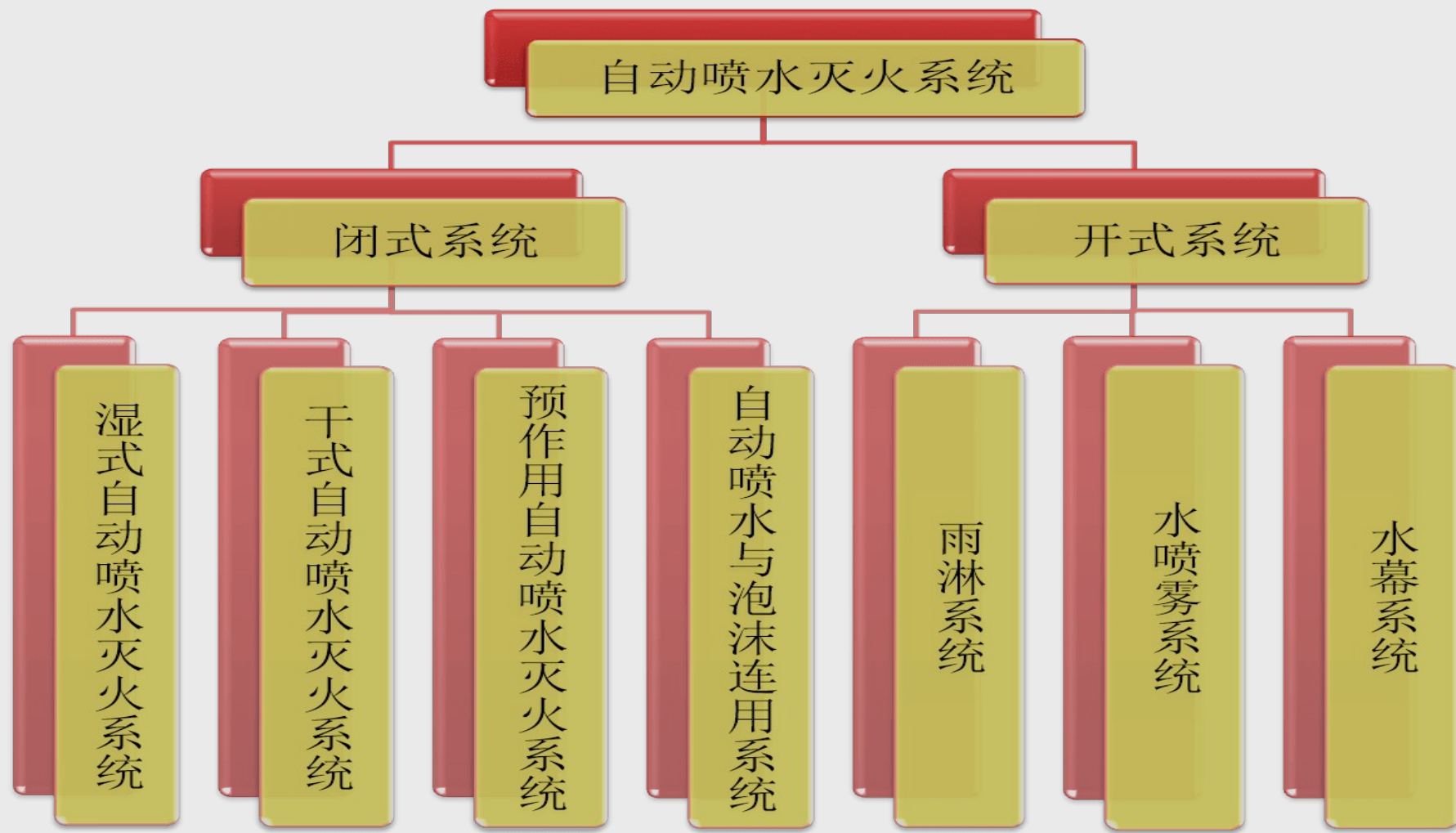



□□□□



□□□□



□□□□□



□□□□

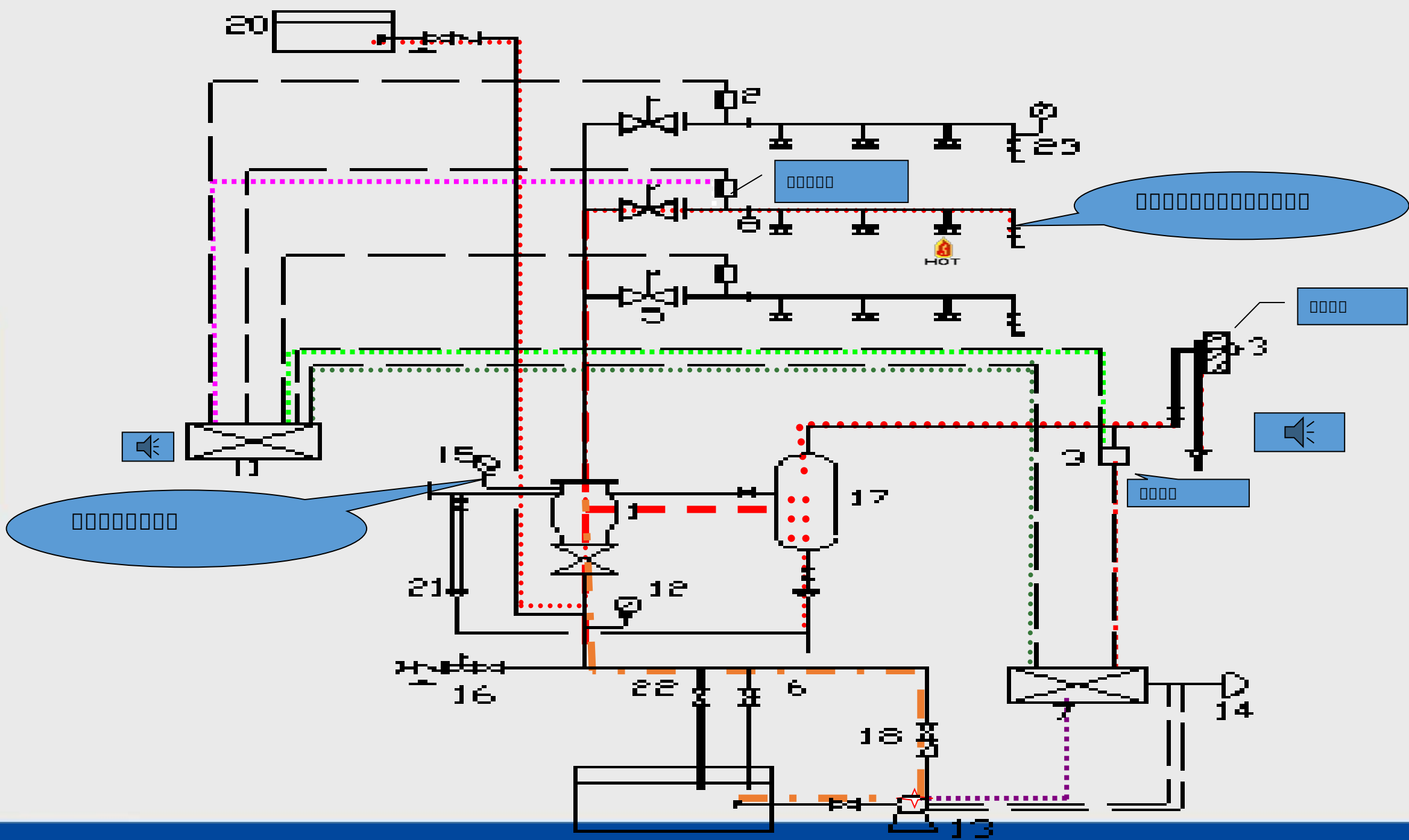

□ □ □ □

□ □ □ □ □

□ □

□ □ □ □ □

□ □

□ □ □ □ □

□ □

□ □ □

□ □



管道

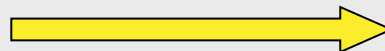

压力表

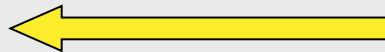

试水阀

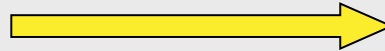

试水接头



□□□□□□□□□□□□□□

□□

1. □□□□□□□□□□
2. □□□□□□□□□□□□□□□□□□□□□□□□□□□□
3. ′′′

□□□□

1. □□□□□□□□□□
 2. □□□□□□□□□□□□□□□□□□□□□□□□□□□□
- 0.05MPa
3. ′′′
 4. □□□□□□□□□□□□□□□□ **5** □□□□□□□□
□□□□□□

□□□□□□□□□□□□

□□□□□□□□

□□□□□□□□

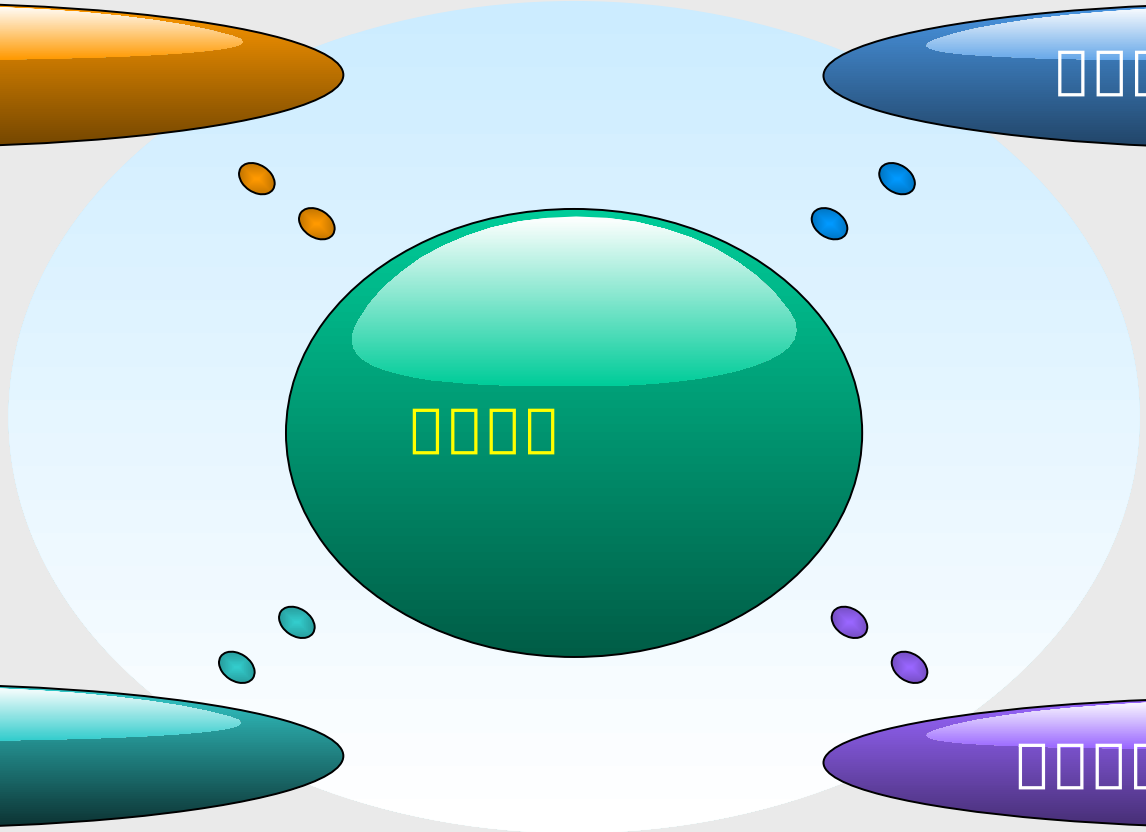

□□□□□□□□

□□□□□□□□





□□□□□□□□□□□□□□□□
□□□□□□□□□□□□

□□□□

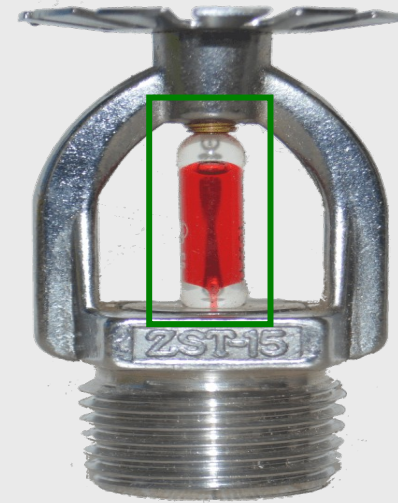

○ ○

□□□□

□ □ □ □ □ □ □

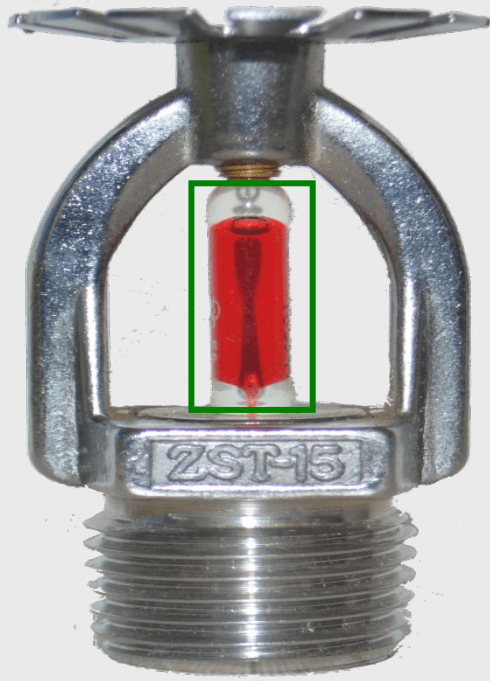

□ □ □ □ □ □ □

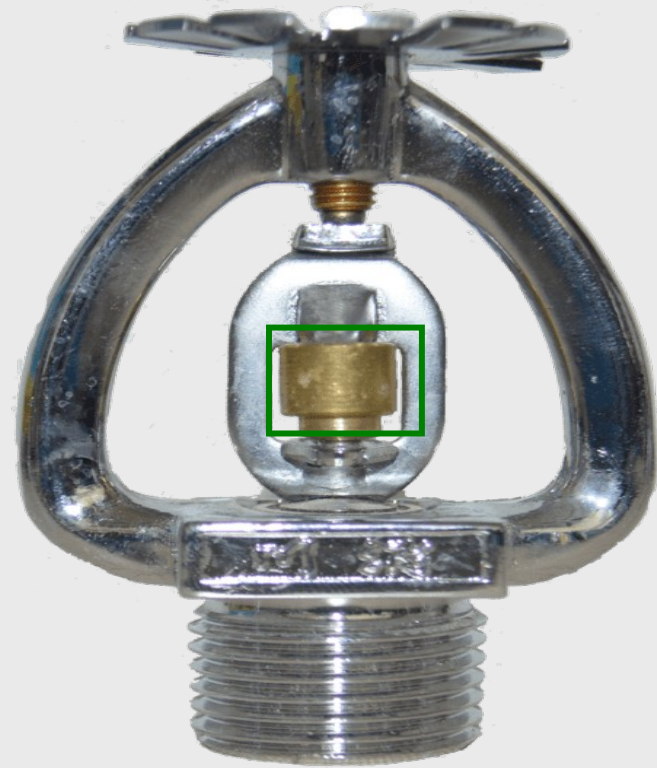

□ □ □ □ □ □ □ □ □ □ □ □ □ □ □ □ □

□ □ □ □ □ □ □



□ □ □ □ □

□ □ □ □ □

□ □ □ □ □

□ □ □ □ □

□ □ □ □ □

□ □ □ □ □ □ □ □ □ □ □ □



□ □ □ □ □ □ □



□ □ □ □ □



—

□ □ □ □ □ □ □ □ □ □ □ □

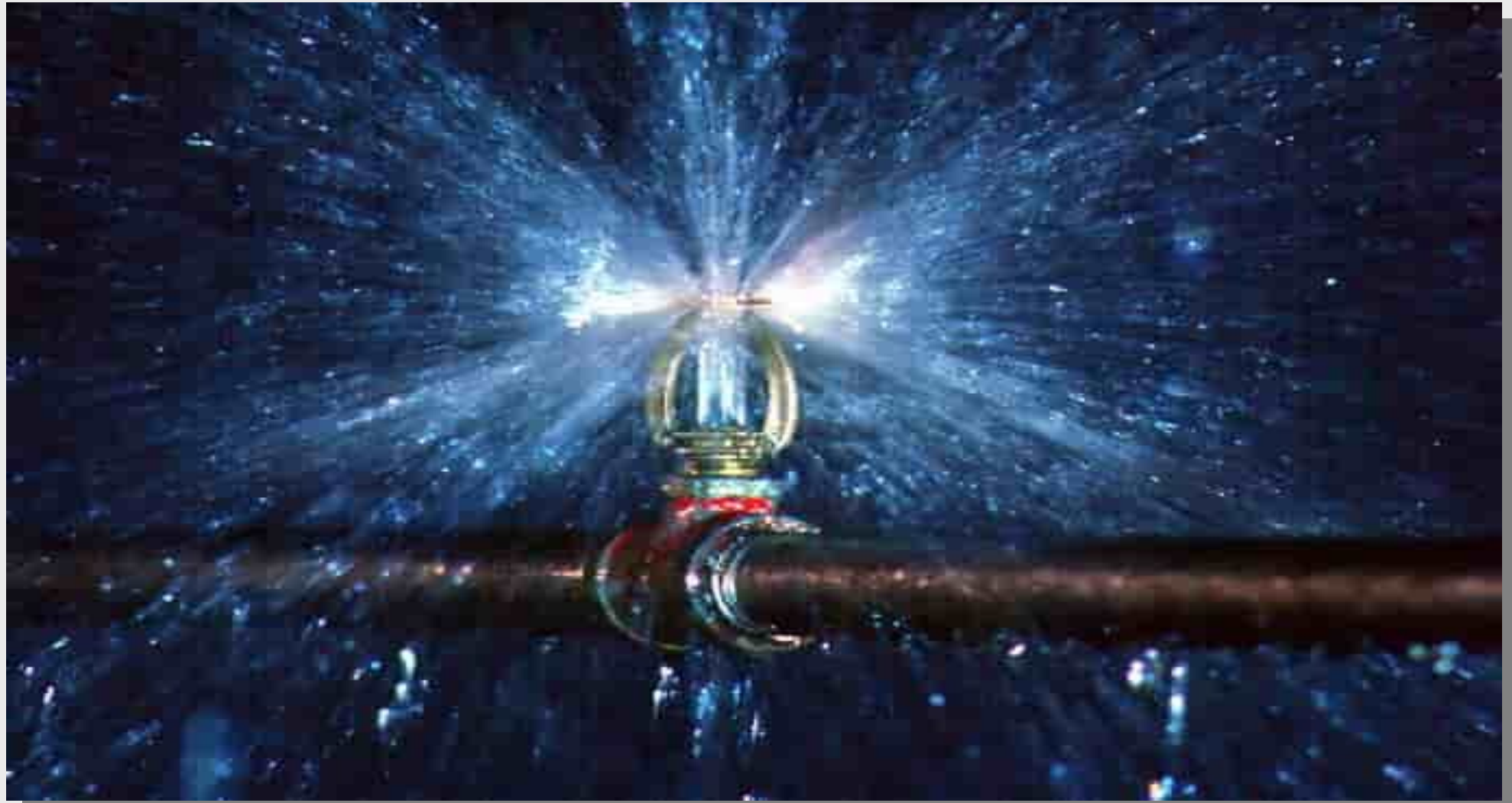

4. □□□□□□□□

□□□□□□□□

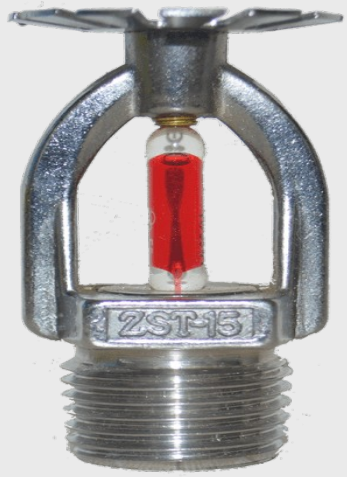
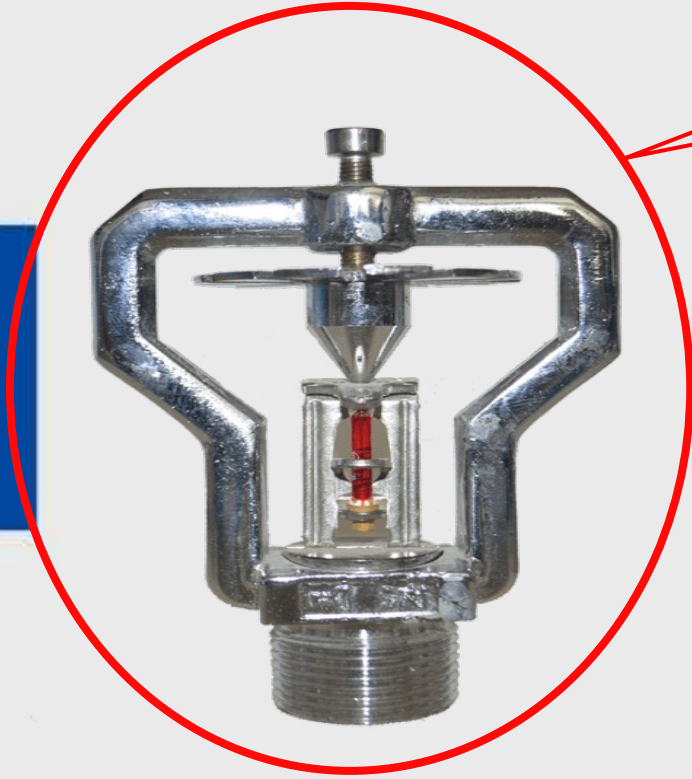

□□□□□□

□□□□□□

□□□□□□□

□□□□□□□□□□ RTI □□□□□□□ **50** □ m·s □ 0.5 □□□□□□□ C □□□□□□□
1.0 □ m/s □ 0.5 °

□□□□□□□□□□ RTI □□□ 50 □ m·s □ 0.5 □ **80** □ m·s □ 0.5 □□□□□□□□□ C □
□□□□□□ 1.0 □ m/s □ 0.5 °

□□□□□□□□□□ RTI □□ 80 □ m·s □ 0.5 □ **350** □ m·s □ 0.5 □□□□□□□□□ C □
□□□□□□ 2.0 □ m/s □ 0.5 °



57°C



68°C



79°C



93°C

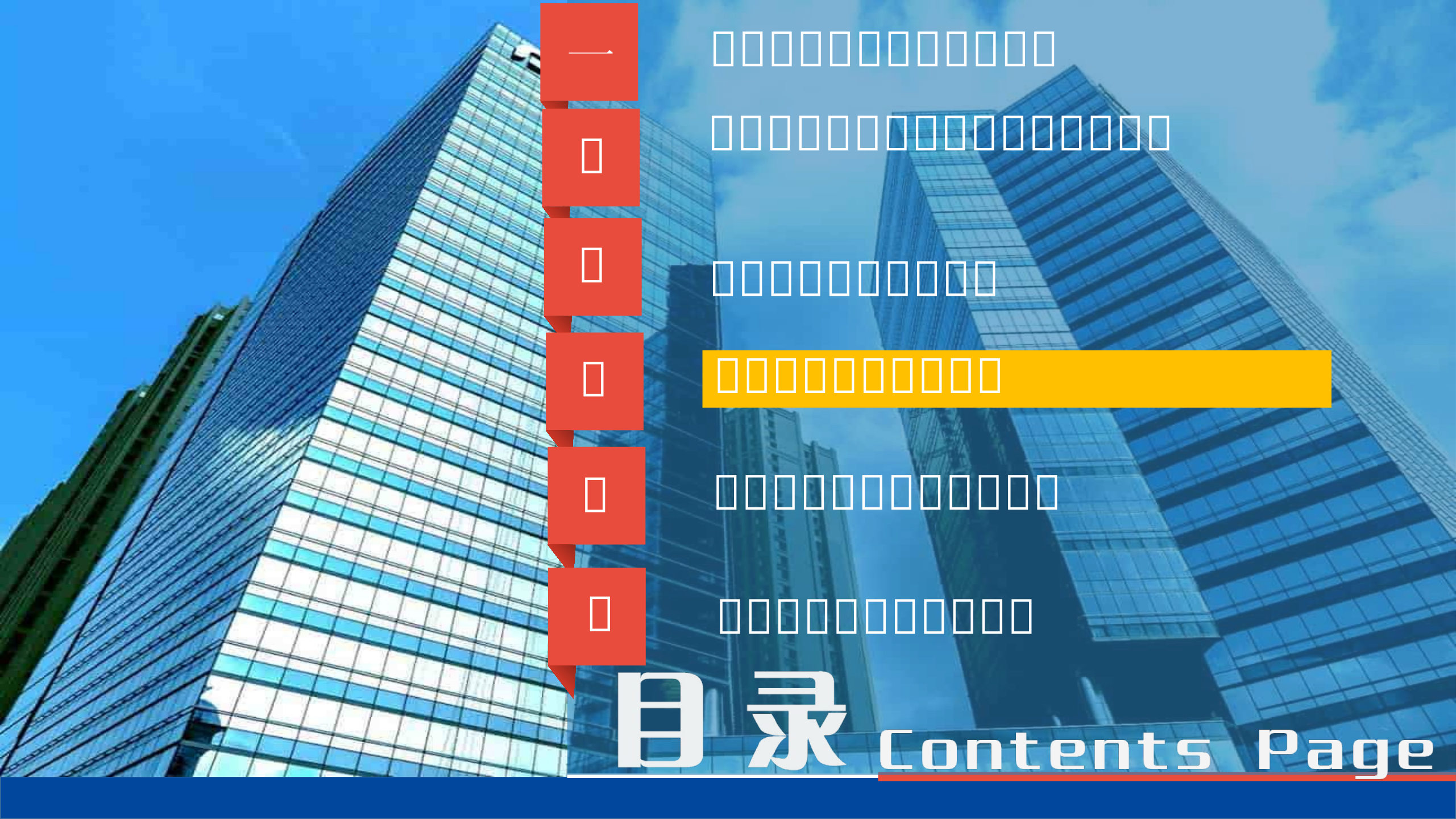

—

□□□□□□□□□□□□□□

□

□□□□□□□□□□□□□□□□

□

□□□□□□□□□□

□

□□□□□□□□□□□□□□

□

□□□□□□□□□□□□□□

□

□□□□□□□□□□□□□□

目录 Contents Page



- / ○
- ○
- ○

- / ○
- ○
- ○



280°C □□□



□□□



□□□□

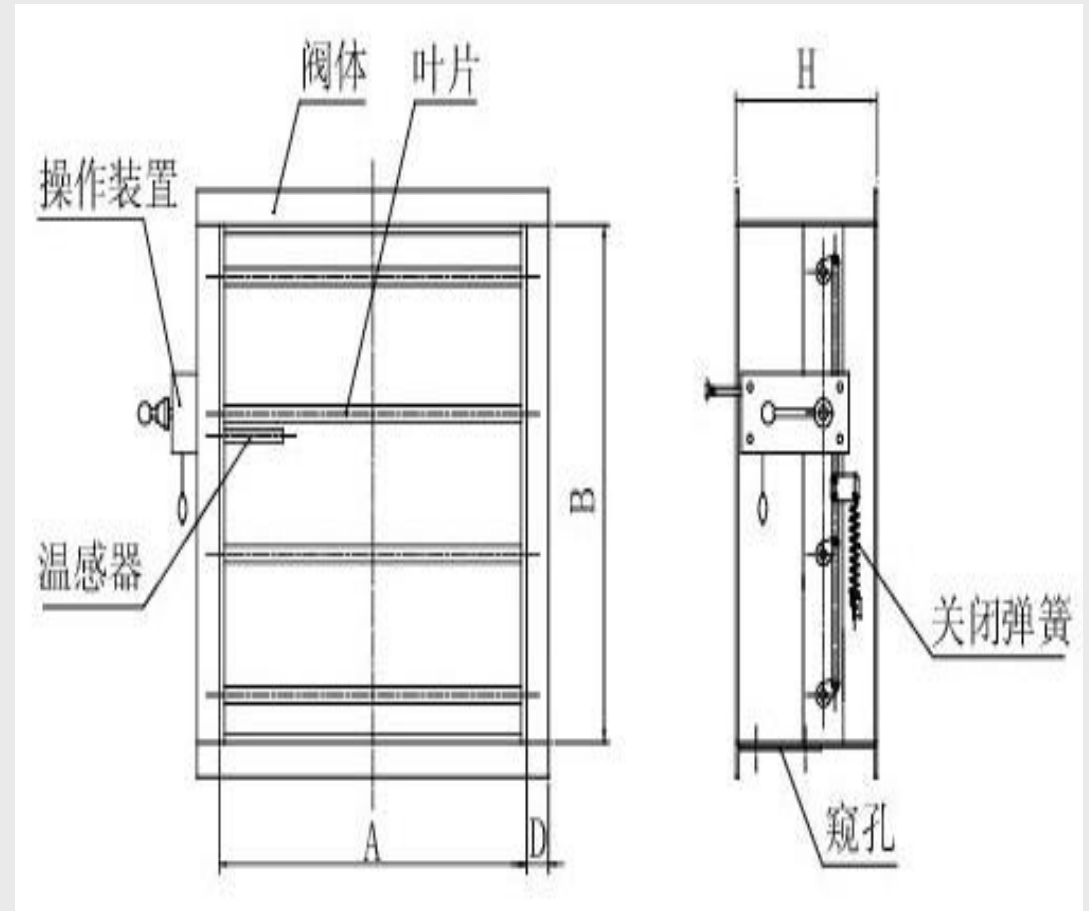

70°C → □



1. □□□□□□□□

2. ✓

3. □□□□□□□□□□□□□□

4. □□□□□□□□□□

5. □□□□□□□□□□

6. **70 °C** □□□□□□ , □□□□□□□□

7. □□□□□□□□□□□□

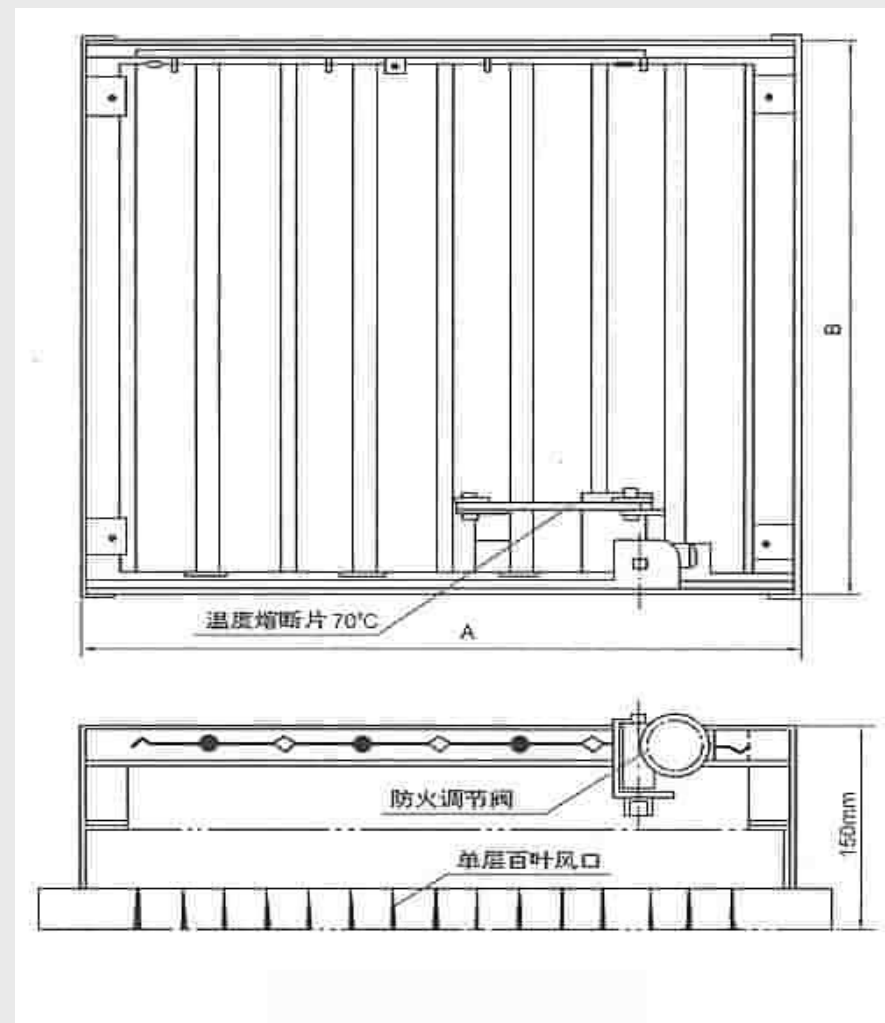



1 .

$1 \geq 2h$

◦

$2 \geq 3h$

◦ ◦ ◦ ◦ ◦

$3 \geq 4h$

◦ ◦ ◦ ◦ ◦ ◦ ◦

2 .

1 1.8

2

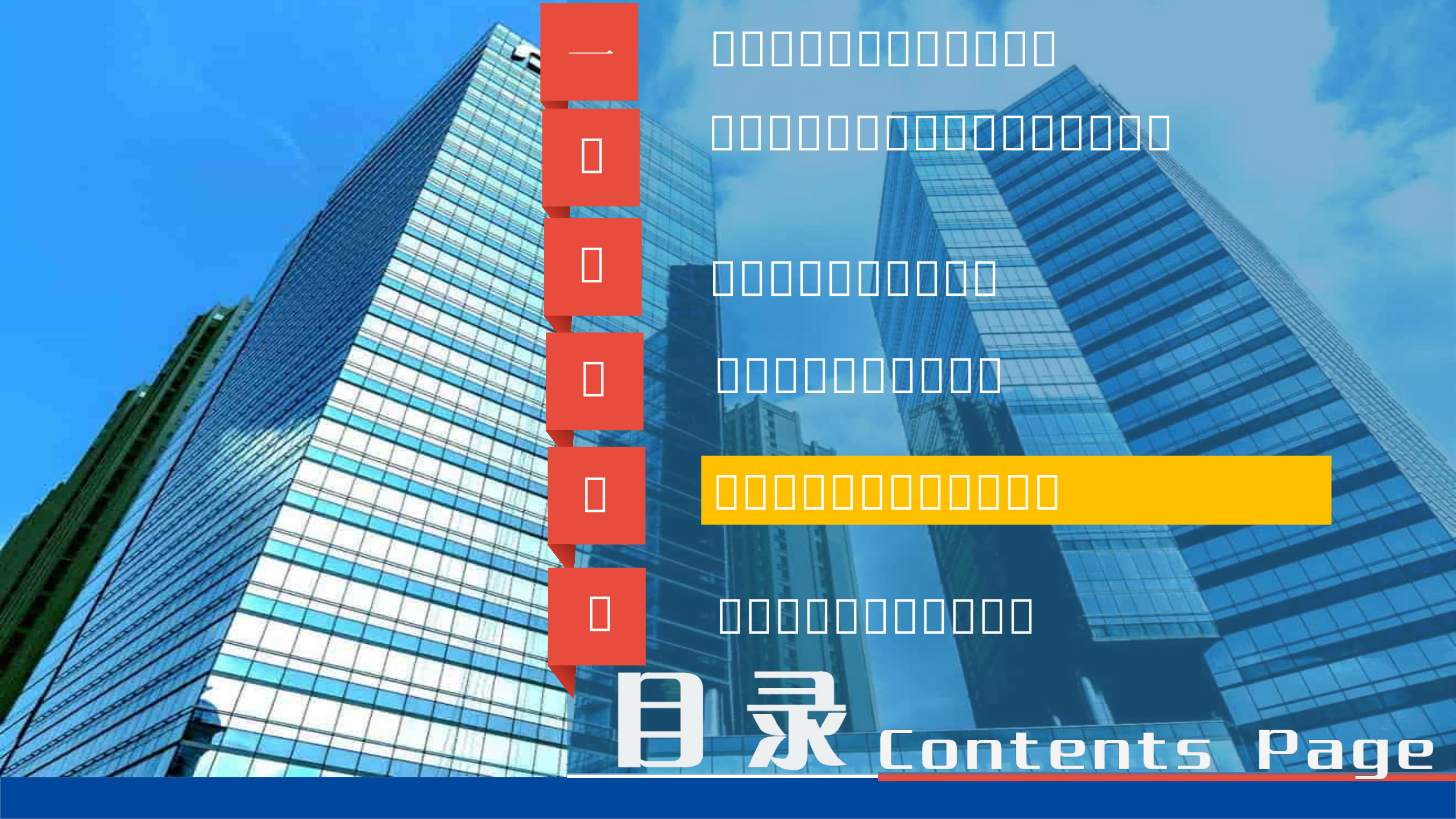

—

□□□□□□□□□□□□□□

□

□□□□□□□□□□□□□□□□

□

□□□□□□□□□□

□

□□□□□□□□□□

□

□□□□□□□□□□□□□□

□

□□□□□□□□□□

目 录 Contents Page

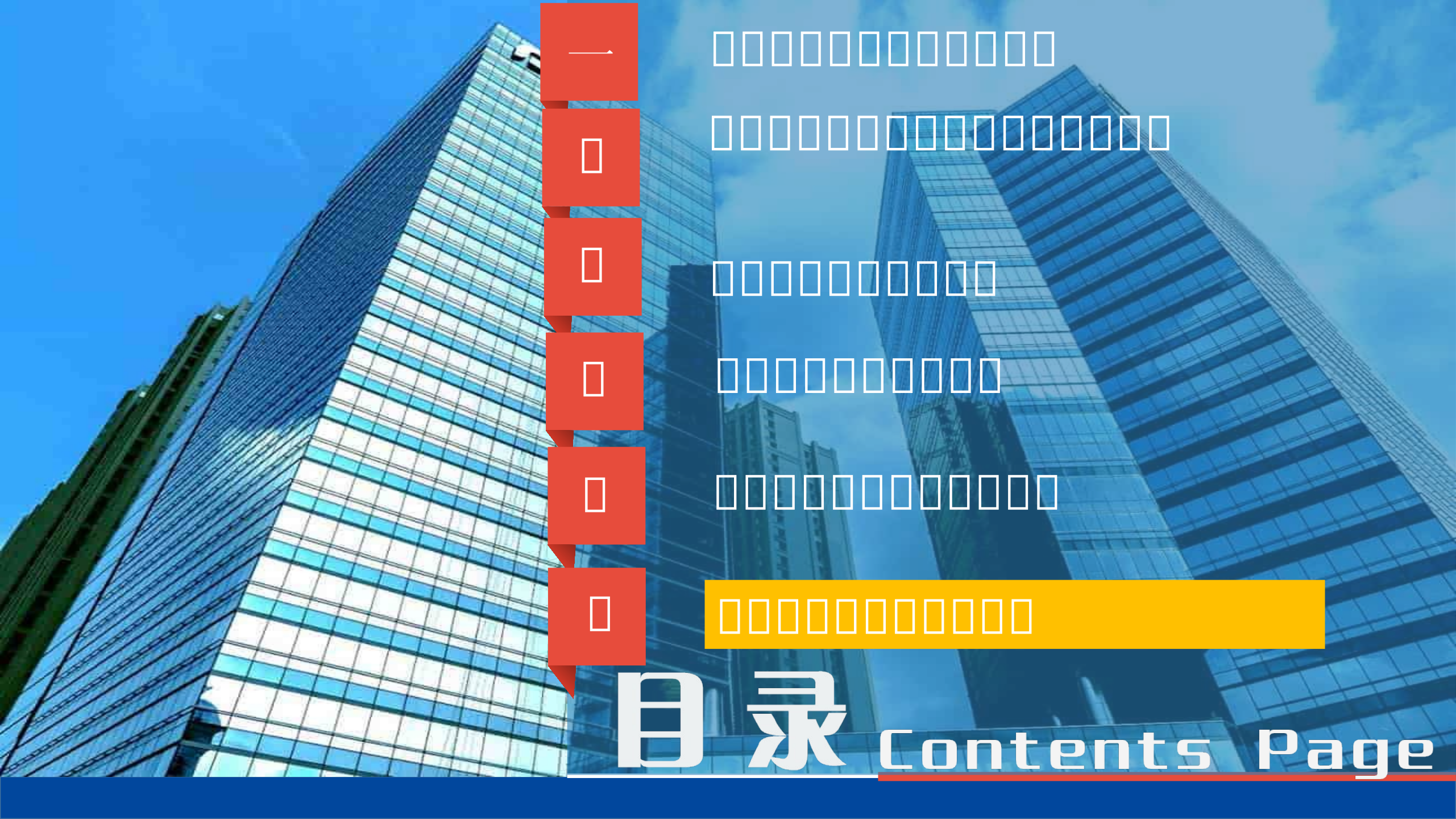

—

□□□□□□□□□□□□□□

□

□□□□□□□□□□□□□□□□

□

□□□□□□□□□□

□

□□□□□□□□□□

□

□□□□□□□□□□□□

□

□□□□□□□□□□□□□□

目录 Contents Page

□ □ □ □ □ □ □

□ □ □ □ □ □

□ □ □ □

///

□ □ □ □ □ □